

Vividia BD-5030i Smartphone Dual-Camera Borescope

User Manual



Note: Do not use this product at the temperature is above 70°C / 160°F.

Parts of BD-5030i borescope:

1. Host

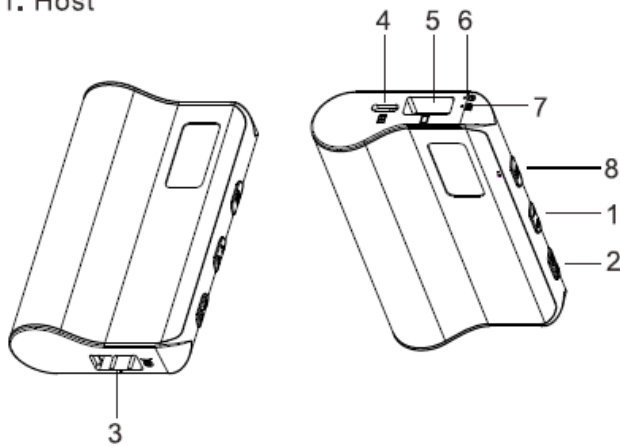

NO.	Description
1	Power on/off , LED adjustment
2	Photo/video button
3	Snake tube USB port
4	Type-C charging port
5	Phone USB port
6	Work indicator
7	Charging indicator
8	Main and Side camera switch

2.Snake tube

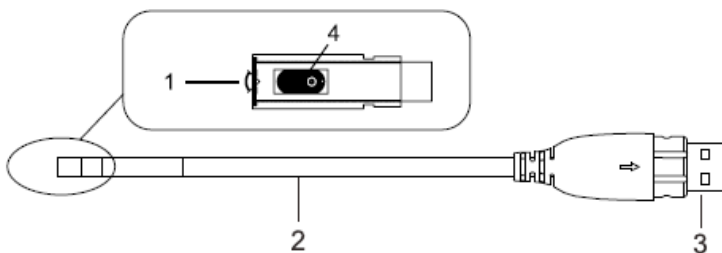

NO.	Description
1	Main Camera
2	Snake tube
3	USB connector
4	Side Camera

Mobile phone Download & installation guide

1.Android mobile device, please scan the QR code below to download and install the app,or search "USee Camera" or "Finder Borescope".

2.For Iphone device please search and install "USee Camera" or "Finder Borescope" in the Appstore,or scan the QR code below to download and install the APP.

3.After the software installed, it will appear the interface below at the first time. One way, click "Next"; Another way, click "File selection" to insert a picture 750*87 for the production of post-test reports.



USee Camera



Finder Borescope

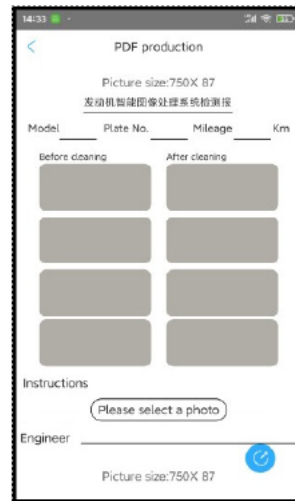

Installation Guide

1.Snake tube installation guide :

As shown in the figure , Align the USB interface and insert and,confirm that the installation is not loose.

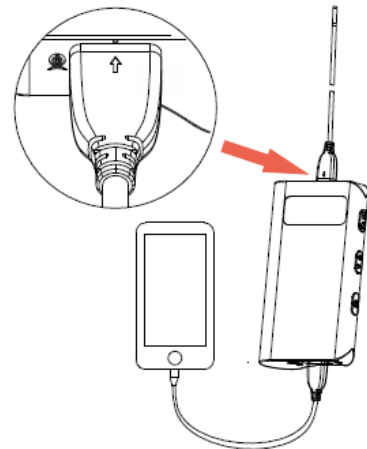

2.Phone installation guide :

As shown in the figure, connect the phone to the host with a data cable and confirm that the installation is not loose.



Operation Instructions



1. Power On/Off

Press  on the host 2 seconds for power on, Work Indicator light up green, Android mobile phone will open the APP automatically (Apple mobile phone needs to be clicked to open the APP ), the snake tube LED is lighting on, the search interface appears, presenting the image, press  2 seconds for power off.



2. Adjust LED

Power on and the LED is the brightest by default, press  to adjust the brightness, it is divided into 3 gears, the 4th gear is LED turn off.

3. Photo and video

Press  on the host take photo, photo is saved in the Finder/CameraData directory of the mobile phone, the format is JPG; Press  on the host 2 seconds to video, video is saved in the Finder/CameraData directory, the format is AVI.

4. PDF Generation

In APP  click settings , click PDF to generate the setting footer, header, LOGO, click PDF Create to input information, as fuel system test sheet can be generated.

5. Charging

Please use the 5V adapter or mobile power to connect Type-c USB cable for charging. The charging voltage and current is 5V/1A, too high voltage may burn out the product. Notice: Fast charging is not supported.

6. Main and Side camera (Only F105D/F108D)

Press  on the host for 2 seconds to switch the camera on the probe, and other functions can be used normally.

Specification

Item No.	BD-5030i	
Probe outer diameter	5.0mm	
Probe	Main camera	Side camera
Viewing angle	70°	70°
Depth of field	30-80mm	20-50mm
Pixel	1280*720	1280*720
LED light	6 LED lights	1 LED lights
Shaped coil length	3.5m/5m/10m	
Power source	2200mAh	
Battery Life	About 2hours	
Frame rate	20fps	
Operating temperature	Snake tube	-10 to 70°C
	Host	-10 to 50°C
Charging voltage	DC5V	
Protection class	Not waterproof	