

# Pipe Inspection Camera System

## Operation Manual



**Model No.: 3499F**  
VS-749A  
VS-749  
VS-749plus

**Model No.: 3499FB**  
VS-749B  
VS-749Bplus



***Read this Operation Manual carefully before using this tool***

## [ INTRODUCTION ]

The pipe inspection system is a powerful set of tools that helps you locate and diagnose problems in a pipeline system. The system is widely used in inspections of Sewer, central air conditioning, chimney, plumbing, building, cable pipe and pipe ventilation systems and other places.

## [GENERAL SAFETY RULES]

### **Precautions**

Read all safety warnings and instructions. Failure to follow warnings and instructions may result in electric shock, fire and/or serious injury.



### **WARNING**

1. Save this operation manual for future reference.
2. Do not operate this device in explosive atmospheres, such as in the presence of flammable liquids, gases, hazardous chemicals, superheated liquid or heavy dust. It may create sparks which may ignite the dust or fumes.
3. The camera head and the push cable are waterproof (when camera installed on rod cable); however, the keyboard and DVR inside the control box are not. Do not expose them to water or rain when the control box is open. This will increase the risk of electrical shock.
4. Avoid using the device in environments of extreme cold, heat or humidity as it may damage the device.
5. Do not drop or press hard on the device.
6. Always backup your data before inserting your SD memory card to this system. The manufacturer is not responsible for any data loss or damage on your SD memory card for any reason.
7. Do not disconnect the unit while recording or playing back. It may damage the unit and/or the SD memory card.
8. Only qualified person are allowed to repair this device. Service or maintenance performed by unqualified person could result in injury.
9. Do not use this device in places where there is high voltage equipment. The device doesn't contain high voltage protection and isolation.
10. Do not use this device in places where there is high voltage equipment. The device doesn't contain high voltage protection and isolation.

## [APPLICATION AND KNOW YOUR TOOL]

### **Application**

Suitable for pipes at diameter of 25mm-200mm. Ability to go through 90° bends in pipe DN45mm(for 23mm camera with 5.2mm rod);and in pipe DN32mm(for 14mm camera with 4.8mm rod)and in pipe DN52mm(for 23mm camera with 6.8mm rod).

### **Know Your Tool**

The pipe inspection system includes the following four main parts: Camera head, Cable reel, Frame and Toolbox((including DVR, control device, battery, keyboard).

The camera head includes high-light white LEDs and a highly scratch-resistant sapphire lens cover; this coupled with stainless steel housing allow the camera to withstand repeated hits in various pipes.

Flexible stainless steel spring and associated components make the camera head possible to go through bend pipes. Also the battery pack provides power supply for the system and the DVR monitor can record video and take photos.

The stable and open composite structure is easier to clean.

## Camera Head

1. Sapphire Lens
2. 304#Stainless Steel Shell
3. Stainless Steel Spring
4. Gold Connector

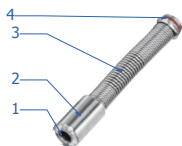

Figure 1. Camera Head

## Package Contents

1. Panel with DVR
2. Wireless keyboard
3. Adapter
4. Car charger
5. Remote control
6. 46mm and 80mm skids for 23mm camera
7. 28mm skid and lock wrench, for 14mm camera head
8. Screw (2x), nut (2x) and waterproof-ring for 23mm camera head
9. Screw Driver
10. Operation manual

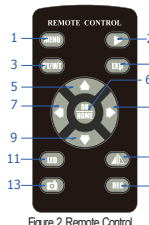

Figure 2. Remote Control

## Remote control

1. Menu: Select Menu
2. Playback: Playback Mode
3. Pt/Wt: Reserve Function
4. Exit: Exit Menu
5. Up: Select Up/Previous Item
6. OK & Home: Confirm/Select Menu
7. Left: Select Left Item
8. Right: Select Right Item
9. Down: Select Down/Next Item
10. Mirror: Mirror And Flip Image
11. LED: Adjust The Led Brightness
12. REC: Start/Stop Recording
13. Photo: Take Photo

## Frame and Cable Wheel

1. Frame
2. Wireless Keyboard Receiver
3. Socket (connect to toolbox)
4. Push Cable
5. Cable Connector (To Camera)

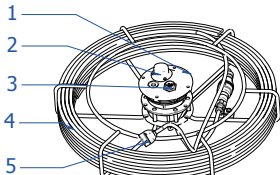

Figure 3. Frame and Cable Reel

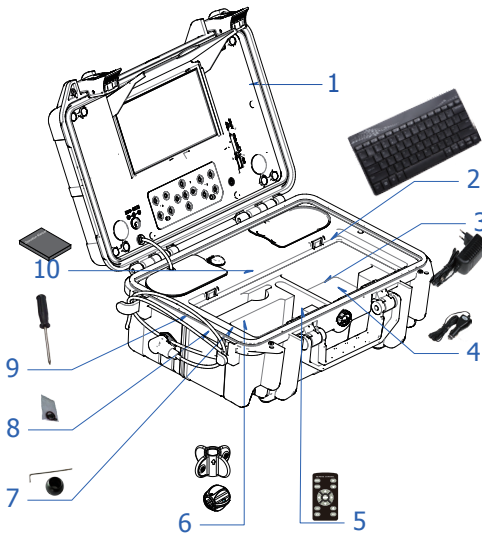

Figure 5. Package Contents

## DVR AND TOOLBOX

1. Power Switch
2. SD Card Slot
3. Color TFT LCD
4. Sun Visor
5. DC In
6. Meter-Zero (Meter Counter Zero Reset Button)
7. Wireless keyboard
8. Aviation Socket
9. Playback: Playback Mode
10. Menu: Select Menu

11. Power Indicator LED
12. Exit: Exit Menu
13. Left: Select Left Item
14. Down: Select Down/Next Item
15. Right: Select Right Item
16. LED: Change The Led Brightness
17. IR For Remote Control
18. REC: Start/Stop Recording
19. Photo: Take Photo
20. Mirror: Mirror And Flip Image
21. Up: Select Up/Previous Item
22. OK & Home: Confirm/Select Menu



Figure 4. DVR and Toolbox

# [ DESCRIPTION SPECIFICATIONS AND STANDARD EQUIPMENT ]

## specifications

	Item	Parameter		
General	Operating Temperature	-10~50°C/+14~+122°F		
	Operating Humidity	30%RH~90%RH		
	Storage Temperature	-20~60°C/+4~+140°F		
	Power adapter	Input:110VAC~240V AC, Output:12V DC 1200mA		
	MEAS.	55×43.5×34.5cm (L×W×H)		
	Weight	13Kg(Approx)		
Camera		<b>Φ23mm camera head</b>		<b>Φ14mm camera head</b>
	Sensor	1/3" CMOS		1/4" CMOS
	TV-Line	480 TV-Line		400 TV-Line
	View Angle	120°		90°
	Focus Distance	20cm (approx)		6-8cm (approx)
	Depth Of Field	100cm(approx)		20cm(approx)
	Camera Size	Φ23mm×51mm (Main body)		Φ14mm×21mm (Main body)
	Camera Length	155mm		125mm
	Front Lens	Sapphire		Sapphire
	Shell Material	304#Stainless Steel		304#Stainless Steel
	Lighting	Built-in 12×LED (White)		Built-in 4×LED (White)
	Water-Proof	20m water (Camera fix on Cable)		10m water (Camera fix on Cable)
	Power Supply	DC9~15V		DC9~15V
Current Consume	40mA (LED OFF), 95mA (LED ON)		40mA (LED OFF), 60mA (LED ON)	
DVR	Screen	7-inch 16:9 super bright high-definition color LCD screen		
	Resolution	800×480 RGB		
	Mirror and Flip	Support image mirror, Flip, Mirror & Flip		
	Video Resolution	PAL 720×576 25FPS Max.		
	Video Encoding	H.264		
	Photograph	720×480/720×576		
	Audio Recording	Local Sound		
	Out Put	TV and Audio output		
	External Memory	Support SD Memory Card up to 32GB		
	LED Driver	Built-in Dimmer		
	Play Back	Video, Photo and Audio		
	Language	English, German, French, Spanish, Italian, Chinese, Japanese, Russian, Portuguese		
	Power Supply	DC 6~12V input		
	Current Consume	700mA Max		
Battery Capacity	7.4V 5200mAh Li-ion Battery			
A Single Charge Work Time	6 Hour			
Charge Time	8 Hour			
Wireless keyboard	Keyboard Compatibility	Support Specific PC Wireless keyboard		
	Typing Language	English		
	Max Characters	384		
	Hide Characters	Quick One Key hiding		
	Precision of Meter	Counter ±0.5%		
	Meter and Feet Switch	Support		
	Set Zero	Support		
	Power Consume	40mA @ 12V DC		
	Waterproof	P66 (for connection ports panel only)		
Cable Wheel	Cable Diameter	Φ4.8mm	Φ5.2mm	Φ6.8mm
	Cable Length	20/30/40 meter (Optional)	20/30/40 meter (Optional)	20/30 meter (Optional)
Tool Box	Size	380×260×150mm(L×W×H)		
	Box color	Black		

# [ INSTALLATION ]



## WARNING

To reduce the risk of serious injury during use, follow these procedures for proper assembly.

### **1. Install cable reel**

Put the cable reel into the frame from the right side, place it in the right direction and then tighten the screw and nut. Pull out the cable with care, thread it through the hook and lead the cable out. (Figure 6.)

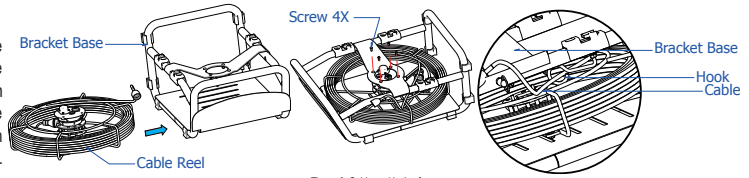

Figure 6. Cable reel in the frame

### **2. Install toolbox**

Step1. Plug one end of the spring cable into the cable wheel aviation socket according to the direction, and tighten the screw.

Step 2. Clip the toolbox holder into the fixed seat on the frame, and push it inside according to the direction.

Step 3.Thread the ball lock pin through the toolbox holder and the frame.

Step 4.Connect the other end of the spring cable with the aviation socket of the toolbox and tighten the screw.(Figure 7.)

### **5. Install SD card**

(Figure 12.)



Figure 12. Install SD Card

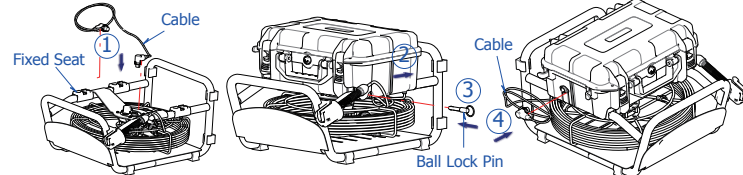

Figure 7. Install toolbox

### **3. Install camera head**

Hold the cable connector in one hand, then screw the camera and fix it on the cable tightly.(Figure 8.)

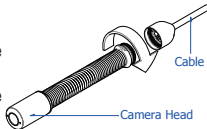
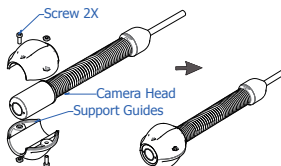

Figure 8. Assembly/Disassembly Camera

### **4. Install guide fitting**

Support Guide are designed to help position the camera towards the middle of the pipe.

#### **1. 23mm camera head**



D46 Applicable to 2.5"-3.5" pipe.  
Figure 9. Install 46 Support Guides

#### **a. Install 46 support guides.**

Sleeve the camera heads with 46 Support guide. (Figure 9.)

#### **b. Install 80 support guides.**

Mount the 80 support guide onto the stainless steel camera head. Then tighten the screw by screwdriver. (Figure 10.)

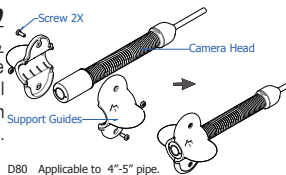

D80 Applicable to 4"-5" pipe.  
Figure 10. Install 80 Support Guides

#### **2. 14mm camera head**

#### **Install 28 support guides.**

Mount the 28 support guide onto the stainless steel camera head. Then tighten the screw by Wrench. (Figure 11.)

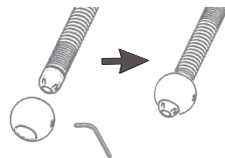

D28 Applicable to 1.5" -2" pipe.  
Figure 11. Install 28 Support Guides

### **6. Turn on the DVR.**

# [ FUNCTION GUIDE AND OPERATING INSTRUCTIONS ]

## DVR Icon

1. SD Card
2. Battery Level
3. Image Reverse
4. Image Reverse & Mirror
5. Image Mirror
6. Timestamp
7. LED Brightness
8. Record
9. Meter Counter

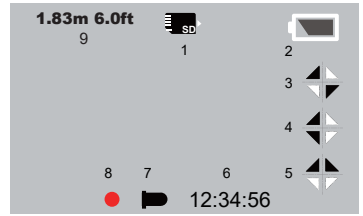



Figure 13. Screen icon Definition

## [ FUNCTION GUIDE ]

### 1. Live video

Press [  ] to turn on/off DVR to enter the live video mode, then press [  ] to enter playback mode.









Press [  ] to start/stop recording.

Press [  ] to mirror or/and reverse the image.

Press [  ] adjust the brightness of camera LEDs.

Press [  ] to take a picture.



### 2. Video Option

Press [  ] to enter the video option menu. Press [  ] and [  ] to select items that you need, press [  ] to confirm the selection. Press [  ] or [  ] to change the value. Press [  ] to save the setting. Press [  ] to exit video option and save.



- Size D1 (720\*576) / VGA (640\*480) / QVGA (320\*240)
- Video Seg: 10min/20min/30min/40min/OFF. Set 10-40min to restrict files length and open cycle-cover. Elder files will be covered by new files when SD card is full. Set OFF to close this function.
- Meter Counter: Reserve function.
- Sound: Turn on/off the local sound in Video Recording.
- Timestamp: Enable/Disable time stamp on screen.

### 3. Playback

Press [  ] the button to enter the playback, the user can browse, preview and playback media files.

Press [  ] and [  ] to browse and select media files.

Press [  ] to confirm the selection and preview media file. Press [  ] to preview the previous file. Press [  ] to

preview the next file. Press [  ] to playback video. Press [  ] to enter the play setting.

- Delete: Delete media files.
- Slide Show: 3sec/5sec/10sec. To set interval time of the slide shows.
- Protection: To protect important media files.
- Thumbnail: Browse 9 media files per page.
- File List: Browse 3 media files per page.
- LCD: LCD brightness.

### 4. Playing Movie

[  ] Pause/Play movie, [  ] Stop play movie, [  ] Rewind, [  ] Forward, you can press [  ] to set speed rate of rewind/forward.

### 5. SETUP

Press [  ] to enter the preferences of Record/Playback. Press [  ] enters Setup menu.

The following items are in the setup menu.

- Format: format SD card.
- LCD: LCD brightness.
- Language: English, German, French, Spanish, Italian, Chinese, Japanese, Russian, Portuguese.
- Sys. Reset: Reset all setting.
- Light frequency, 50Hz/60Hz, specifying your ambient light frequency.
- TV output: PAL/NTSC.
- Date input: To set date and time.

## [ WIRELESS KEYBOARD OPERATION ]

The keyboard text writer is used to type characters with the wireless keyboard and display on screen. The characters can be displayed in recorded video or captured photo. It supports max. 384 characters and quick one key hiding characters.

### **Text Input**

1. Typing characters with wireless keyboard. Using arrow key to move cursor, backspace key to delete ,and enter key to change a new line.
2. Esc key to hide or appear all characters.Ctrl + Del to delete all characters.
3. You can type and edit characters while recording, the typing and editing will be recorded in the video files.
4. The typed characters will be stored in memory.

**Note: You have to change the wireless keyboard Receiver together when changing a new keyboard.**

### **Backstage Operation**

You can press "F1" or "F2" key within 5 seconds after DVR monitor starts to enter F1 or F2 backstage operation.

1. The first line is reserved for user to type company name, name of operator, phone number etc., and these contents won't be hid by pushing ESC button. You can edit the contents by using F1 key, and press Enter key to save and exit.
2. Please refer to meter counter operation prior to this operation. Using F2 background key to select the unit of length or the total length of push cable (this is designed in case the total length of push cable is changed). When the "L=" flashes, press up or down arrow key to select the unit of length, or select the correct total length. Press enter key to save and exit.

## [ METER COUNTER OPERATION ]

1. Press the meter-zero button to set the meter to zero on screen display.
2. Change the unit of length or the total length of push cable, please refer to 'F2 backstage operation' contents in the wireless keyboard operation.

**Note1: The deviation of MC will increase if the total length is not correct. You need to select the correct total length to decrease the deviation. Use this function to change the displayed total length when the push cable is cut off for more than 3 meters.**

**Note 2: Turn on the system before pulling out the push cable from the cable reel. It can decrease the deviation of the MC.**

## [ PUSH CABLE AND CAMERA OPERATION ]

### At the job site

1. Always wear rubber gloves to operate the camera for health and safety reasons. Properly positioning the cable reel will save time and strength to push out and in the cable, and minimize the rate of equipment damage.
  - When pushing, the end of your stroke should be as close to the entry as possible. Standing too far back with an excess of cable between your hands and the entry may cause the cable to fold on itself outside the entry and damage the cable.
  - Try to keep the push cable away from sharp edge of a pipe entry because this may cause damage. If the camera does not seem to go any farther, **DO NOT FORCE TO PUSH THE CAMERA!** Try another entry if possible.

**NOTE! Hands should be close to the line opening. DONOT catch the cable on the edge of an entry and continue to push.**

2. Always try to run water down the pipe under going inspection. This will keep the system much cleaner, and allow you to push noticeably farther with less friction. If the water is preventing you from seeing an area of importance, temporarily turn it off.
3. When push the push cable through the pipeline by steady and slowly, a short distance entry per time, keeps the hands at the entrance, so that can control the push cable and prevent it stuck, bent or scratch.
4. When inspecting a pipe, most of the time a slow steady push through the system works the best. At changes in direction such as P-traps, Tee's, Y's, Elbows, etc. It is usually necessary to give a little extra push in the bends. Back the camera head approximately 8" (20cm) from the bend, if necessary, and give it a quick push, "popping" the camera through a turn, using the least amount of force required. Try to be as gentle as possible, and do not hammer or snap the camera head through corners. After some practice, you may learn that the best way to inspect a section of pipe is to push the camera through quickly. Then draw the camera back home slowly and evenly.
5. Make sure the sapphire window is clean prior to entry. Some users claim that a slight film of detergent on the lens minimizes the possibility of grease sticking to the port. If necessary, take advantage of any standing water in the pipe to wash the front of the camera by jiggling it in the water.
6. When you place the camera head into the pipe remember, as the materials of pipe vary, it will be necessary to adjust the lighting settings to maximize picture quality.
7. The system can travel through multiple 45 and 90 degree bends and wyes. Do not, however, try to force it through a P-trap or tee if there is a large amount of resistance.

**NOTE! Do not try to use the camera head to clear obstructions. This System is a diagnostic tool, not a drain cleaner. Using the camera head to clear obstructions could damage the camera head or cause it to be caught in the obstruction.**

8. Do not attempt to remove or stores push cable on the reel solely by turning the reel itse if. You can manually push or pull cable from the reel and wind or unwind it.

9. If the camera sits in a pipe, or an enclosed environment, heat will build-up. This may lead to the camera head overheating which will cause fuzzy lines to appear on the monitor. In the event, this happens, turn off the system, remove the camera from the pipe (or enclosed environment) and let the camera head cool for 10 to 15 minutes. Running water into the line will also help cool the camera head. Always use the minimum illumination required to maximize picture quality and to avoid excessive heat build-up.

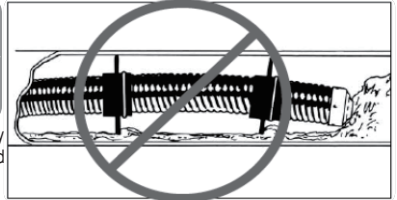

Figure 4 Improper operation

**NOTE! The camera head can get HOT! When finished with your inspection, or if taking a prolonged break in the middle of the inspection, turn off the system.**

### Retrieving the push cable

1. Once the inspection has been completed, pull the push cable back with slow, steady force. Do not force the push cable or exert excessive force. This could damage the camera or push cable. The push cable may get hung up while being retrieved, and may need to be manipulated as did during insertion.
2. Once the inspection has been completed, pull the push cable back with slow, steady force. Do not force the push cable or exert excessive force. This could damage the camera or push cable. The push cable may get hung up while being retrieved, and may need to be manipulated as did during insertion.

**Note! NEVER USE SOLVENTS to clean any part of the system. Substances like acetone and other harsh chemicals can cause cracking of the camera ring, which could affect waterproofing.**

3. Storing the push cable into the cable reel. One hand holds the push cable, the other hand close to the cable wheel. Slowly and gently push the push cable slide via the hook of the handle, cable reel will rotate and store the push cable inside.

**Note! The hands should be close to the cable wheel when storing the push cable. Push the push cable a small piece every try. Push a long distance can cause the push cable bend or broken.**



## [ BATTERY SAFETY AND USING GUIDE ]

### Using safety

Read the following battery precautions before charger, to reduce the risk of electrical shock.

1. Recharge batteries with accessory charging units.
2. Check the power units every time before using the equipment, be sure no problem, use of unauthorized parts may result in electrical shock, fire and/or serious personal injury or damage other instruments and system.
3. Never connects the car charger to any 24 volt cigarette lighter slot. It will harm the battery and DVR.
4. Do not short circuit, it may cause fire, electrical shock.
5. Do not charge the battery under rain or wet conditions. Water entering the charger will increase the risk of electrical shock.
6. If the charger and battery are damaged, do not use or stop to charge. It may cause electrical shock.
7. Don't disassemble the case, only qualified repair person can repair and maintenance.
8. Properly dispose of the battery. Exposure to high temperatures can cause the battery to explode. So do not dispose of in a fire. Some countries have regulations concerning battery disposal. Please follow all applicable regulations.
9. Do not touch anything which out from battery, which would burn or damage the skin, once touches please flush with water. If in eyes, immediately get medical help fast.

### Using Guide

Follow the steps as below to reduce the injury of the electric shock.

1. Power indicator LED will be red during charging, will be turned to green when charged fully. If battery empty for a long term, it will pre-charge the battery automatically in 10 minutes, and LED will be blinking in red.
2. It needs about 8 hours to charge the battery fully. The battery can charge online, charging and supplying of work will not increase charging times.
3. User can use a power adaptor or car charger to charge the battery. If no use in a long term, take a recharge per 6 month, to ensure the battery in normal working status.

## [ OTHERS ]

### Troubleshooting

<b>Problem</b>	<b>Probable fault location</b>	<b>Solution</b>
Meter is not accurate	Knurled wheel slip	Fit glassfiber cable into the guide solt and hook.
	not set to zero	Press reset button to set zero.
No image	Cable connection faulty or loosely	Check cable connection, clean and reconnect if necessary
	Camera connector soiled	Clean the camera connector
	Wrong SD memory card	Turu off power and replace SD card
	Wrong setting	Enter the setup menu and select reset
DVR Can not boot	No power	Recharge
	Transient short circuit in the cable cause the battery short circuit protection.	Recharge the DVR more than 2 seconds with adaptor or car-charger to activate the battery.
Can not input Characters	The wireless keyboard low battery	Chang battery
	Wireless Keyboard or Receiver fault	Check the Keyboard Receiver and the keyboard on a PC
The deviation of MC more than 0.5%	select the wrong total length	Re-select the correct total length. You can press F2 key when the machine boot within 5 sec to enter background to select it.
	Pull out cable more than 3 meters before turning on the system.	Turn on the system before pulling out the push cable from the cable reel.

### FCC Statement

This device complies with part 15 of the FCC Rules. Operation is subject to the following two conditions:

1. This device may not cause harmful interference.
2. This device must accept any interference received, including interference that may cause undesired operation. Any changes or modification not expressly approved by the party responsible for compliance could void the user's authority to operate the device.

### CE

This product complies with standards including Low Voltage Device Directive 73/23/EEC;

### EMC

Directive 89/336/EEC. It passed the subject tests by the authority concerned and is authorized to bear CE mark.

**Camera C23MNS :23mm camera head with self-leveling ( Optional)  
For 5.2mm or 6.8mm rod cable**

Type	Item	Parameter
Image	Sensor	CMOS
	TV-Line	420 TV-Line
	Resolution	720×576
	View Angle	120°
	Focus Distance	20cm (approx)
	Depth-of-Field	100cm(approx)
	Front Lens	Sapphire



Figure 15. Camera C23MNS

**Camera C23MTO :23mm camera head with built-in 512Hz Sonde ( Optional)  
For 5.2mm or 6.8mm rod cable**



Figure 16. Camera C23MTO

Type	Item	Parameter
Image	Sensor	CMOS
	TV-Line	480 TV-Line
	Resolution	960×480
	View Angle	120°
	Focus Distance	20cm (approx)
	Depth-of-Field	100cm(approx)
	Front Lens	Sapphire
Transmitter	Frequency	512Hz
	Transmit Mode	Constant
	Transmission Distance	6 meters open area (max)

**Camera C23MTS :23mm camera with both self-leveling and 512Hz Sonde ( Optional)  
For 5.2mm or 6.8mm rod cable**

Type	Item	Parameter
Image	Sensor	CMOS
	TV-Line	420 TV-Line
	Resolution	720×576
	View Angle	120°
	Focus Distance	20cm (approx)
	Depth-of-Field	100cm(approx)
	Front Lens	Sapphire
Transmitter	Frequency	512Hz
	Transmit Mode	Constant
	Transmission Distance	6 meters open area (max)



Figure 17. Camera C23MTS

















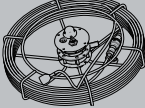

**Camera C14MTO :14mm camera head with built-in 512Hz Sonde ( Optional)  
For 4.8mm fiberglass cable**

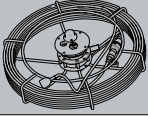

Figure 18. Camera C14MTO

Type	Item	Parameter
Image	Sensor	1/4" CMOS
	TV-Line	400 TV-Line
	Pixel	648(H)x 488(V)
	View Angle	90°
	Focus Distance	6~8cm (approx)
	Depth-of-Field	20cm(approx)
	Front Lens	Sapphire
Transmitter	Frequency	512Hz
	Transmit Mode	Constant
	Transmission Distance	6 meters open area (max)

## ***Part Number List***

No.	Part Number	Part Name	Specifications	Picture
1	C23MNO	23mm camera head	CMOS 480TVL, $\Phi 23 \times 155$ mm, 120° View Angle	
2	C23MNS	23mm camera head	CMOS 420TVL, $\Phi 23 \times 155$ mm, 120° View Angle with Self Leveling	
3	C23MTO	23mm camera head	CMOS 480TVL, $\Phi 23 \times 155$ mm, 120° View Angle with 512Hz Transmitter	
4	C23MTS	23mm camera head	CMOS 420TVL, $\Phi 23 \times 155$ mm, 120° View Angle with Self Leveling, with 512Hz Transmitter	
5	C14MNO	14mm camera head	CMOS 400TVL, $\Phi 14 \times 125$ mm, 90° View Angle	
6	C14MTO	14mm camera head	CMOS 400TVL, $\Phi 14 \times 125$ mm, 90° View Angle with 512Hz Transmitter	
7	8-901	Guide	80 Support Guide	
8	8-923	Guide	46 Support Guide	
9	S2328S	Guide	28 Support Guide	
10	R1820U	Cable Wheel	$\Phi 5.2$ mm cable. push rod and keyboard text writer unit components 20/30/40m length optional.	
	R1830U			
	R1840U			
11	M1820U	Cable wheel and frame	Include frame, coil, cable, push rod and keyboard text writer unit components Cable length: 20/30/40m (optional)	
	M1830U			
	M1840U			
12	R1120U	Cable Wheel	$\Phi 4.8$ mm cable. push rod and keyboard text writer unit components 20/30/40m length optional.	
	R1130U			
	R1140U			
13	M1120U	Cable wheel and frame	Include frame, coil, cable, push rod and keyboard text writer unit components Cable length: 20/30/40m (optional)	
	M1130U			
	M1140U			
14	R1320U	Cable Wheel	$\Phi 6.8$ mm cable. push rod and keyboard text writer unit components 20/30m length optional.	
	R1330U			
15	M1320U	Cable wheel and frame	Include frame, coil, cable, push rod and keyboard text writer unit components Cable length: 20/30m (optional)	
	M1330U			
16	3-412	Remote Control	13 Key Remote Control	
17	K7924K	Wireless keyboard	Wireless keyboard and receiver	
18	A18009	Cable	6-6 pin spring type connection cable (plugs at 90° shape)	
19	2-312	Adaptor	DC 12V 1.5A Adaptor	
20	2-323	Car Charger	DC 12V 2A Car Charger	